

BC517

Darlington Transistors

NPN Silicon

Features

- These are Pb-Free Devices*

MAXIMUM RATINGS

| Rating | Symbol | Value | Unit |
|---|----------------|-------------|----------------------------|
| Collector - Emitter Voltage | V_{CES} | 30 | Vdc |
| Collector - Base Voltage | V_{CB} | 40 | Vdc |
| Emitter - Base Voltage | V_{EB} | 10 | Vdc |
| Collector Current - Continuous | I_C | 1.0 | Adc |
| Total Power Dissipation @ $T_A = 25^\circ\text{C}$ Derate above $T_A = 25^\circ\text{C}$ | P_D | 625 12 | mW mW/ $^\circ\text{C}$ |
| Total Power Dissipation @ $T_C = 25^\circ\text{C}$ Derate above $T_C = 25^\circ\text{C}$ | P_D | 1.5 12 | W mW/ $^\circ\text{C}$ |
| Operating and Storage Junction Temperature Range | T_J, T_{stg} | -55 to +150 | $^\circ\text{C}$ |

THERMAL CHARACTERISTICS

| Characteristic | Symbol | Max | Unit |
|---|-----------------|------|---------------------------|
| Thermal Resistance, Junction-to-Ambient | $R_{\theta JA}$ | 200 | $^\circ\text{C}/\text{W}$ |
| Thermal Resistance, Junction-to-Case | $R_{\theta JC}$ | 83.3 | $^\circ\text{C}/\text{W}$ |

Stresses exceeding Maximum Ratings may damage the device. Maximum Ratings are stress ratings only. Functional operation above the Recommended Operating Conditions is not implied. Extended exposure to stresses above the Recommended Operating Conditions may affect device reliability.



ON Semiconductor®

<http://onsemi.com>

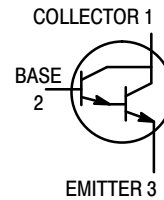

TO-92
CASE 29
STYLE 17

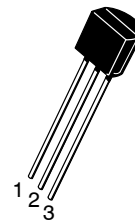

STRAIGHT LEAD
BULK PACK

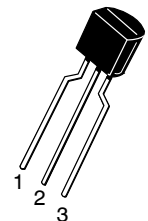

BENT LEAD
TAPE & REEL
AMMO PACK

MARKING DIAGRAM

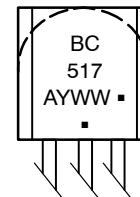

- A = Assembly Location
- Y = Year
- WW = Work Week
- = Pb-Free Package

(Note: Microdot may be in either location)

ORDERING INFORMATION

| Device | Package | Shipping† |
|-----------|--------------------|--------------------|
| BC517G | TO-92 (Pb-Free) | 5000 Units / Bulk |
| BC517RL1G | TO-92 (Pb-Free) | 2000 / Tape & Reel |
| BC517ZL1G | TO-92 (Pb-Free) | 2000 / Ammo Pack |

†For information on tape and reel specifications, including part orientation and tape sizes, please refer to our Tape and Reel Packaging Specifications Brochure, BRD8011/D.

*For additional information on our Pb-Free strategy and soldering details, please download the ON Semiconductor Soldering and Mounting Techniques Reference Manual, SOLDERRM/D.

BC517

ELECTRICAL CHARACTERISTICS ($T_A = 25^\circ\text{C}$ unless otherwise noted)

| Characteristic | Symbol | Min | Typ | Max | Unit |
|---|---------------|--------|-----|-----|------|
| OFF CHARACTERISTICS | | | | | |
| Collector - Emitter Breakdown Voltage ($I_C = 2.0 \text{ mA}$, $I_{BE} = 0$) | $V_{(BR)CES}$ | 30 | - | - | Vdc |
| Collector - Base Breakdown Voltage ($I_C = 10 \mu\text{A}$, $I_E = 0$) | $V_{(BR)CBO}$ | 40 | - | - | Vdc |
| Emitter - Base Breakdown Voltage ($I_E = 100 \mu\text{A}$, $I_C = 0$) | $V_{(BR)EBO}$ | 10 | - | - | Vdc |
| Collector Cutoff Current ($V_{CE} = 30 \text{ Vdc}$) | I_{CES} | - | - | 500 | nAdc |
| Collector Cutoff Current ($V_{CB} = 30 \text{ Vdc}$, $I_E = 0$) | I_{CBO} | - | - | 100 | nAdc |
| Emitter Cutoff Current ($V_{CB} = 10 \text{ Vdc}$, $I_C = 0$) | I_{EBO} | - | - | 100 | nAdc |
| ON CHARACTERISTICS (Note 1) | | | | | |
| DC Current Gain ($I_C = 20 \text{ mA}$, $V_{CE} = 2.0 \text{ Vdc}$) | h_{FE} | 30,000 | - | - | - |
| Collector - Emitter Saturation Voltage ($I_C = 100 \text{ mA}$, $I_B = 0.1 \text{ mA}$) | $V_{CE(sat)}$ | - | - | 1.0 | Vdc |
| Collector - Emitter Saturation Voltage ($I_C = 10 \text{ mA}$, $V_{CE} = 5.0 \text{ Vdc}$) | $V_{BE(on)}$ | - | - | 1.4 | Vdc |
| SMALL-SIGNAL CHARACTERISTICS | | | | | |
| Current-Gain - Bandwidth Product (Note 2) ($I_C = 10 \text{ mA}$, $V_{CE} = 5.0 \text{ Vdc}$, $f = 100 \text{ MHz}$) | f_T | - | 200 | - | MHz |

1. Pulse Test: Pulse Width = 300 μs , Duty Cycle 2.0%.

2. $f_T = |h_{fe}| \cdot f_{test}$

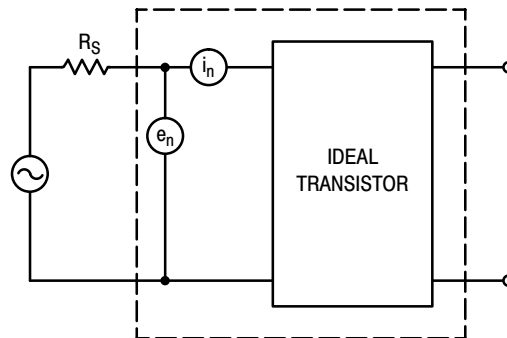

Figure 1. Transistor Noise Model

NOISE CHARACTERISTICS

($V_{CE} = 5.0 \text{ Vdc}$, $T_A = 25^\circ\text{C}$)

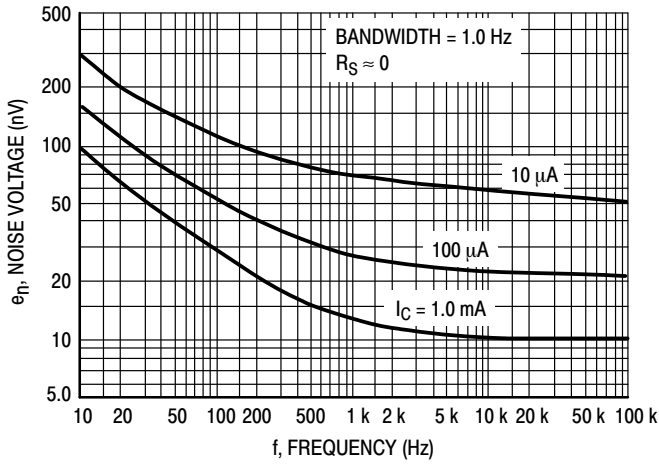

Figure 2. Noise Voltage

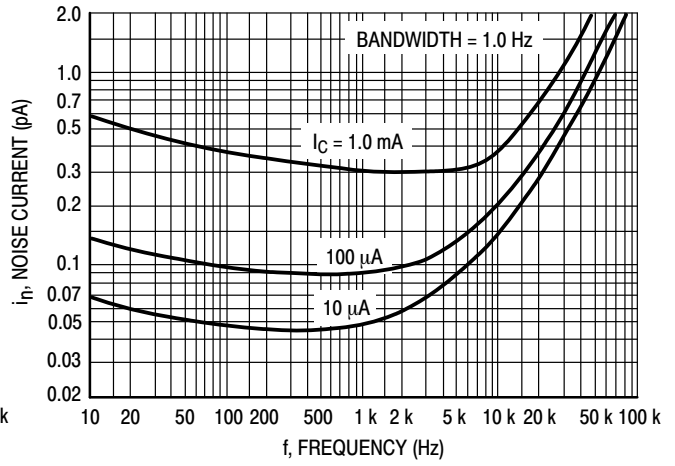

Figure 3. Noise Current

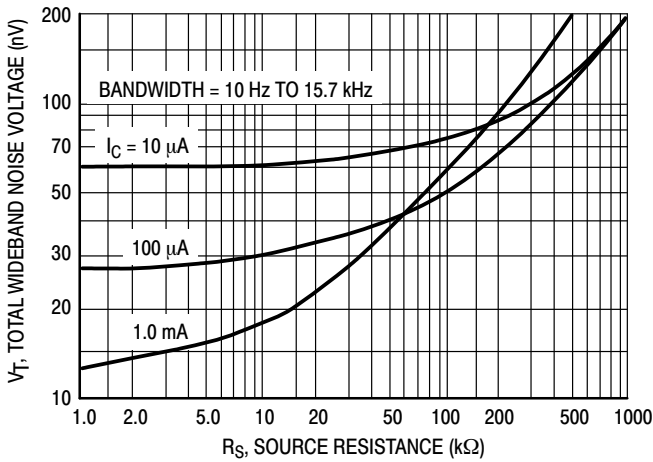

Figure 4. Total Wideband Noise Voltage

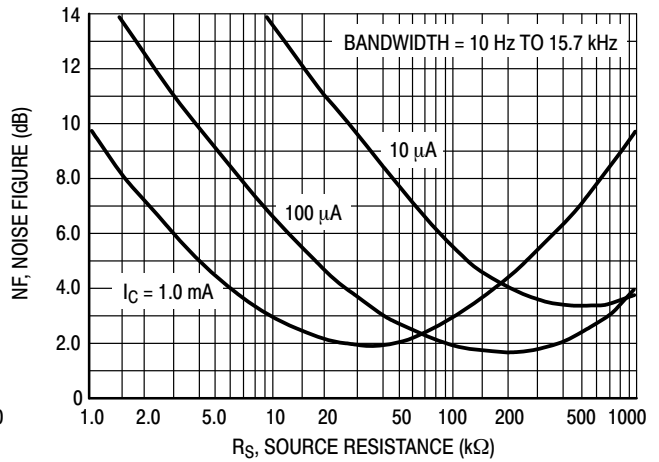

Figure 5. Wideband Noise Figure

SMALL-SIGNAL CHARACTERISTICS

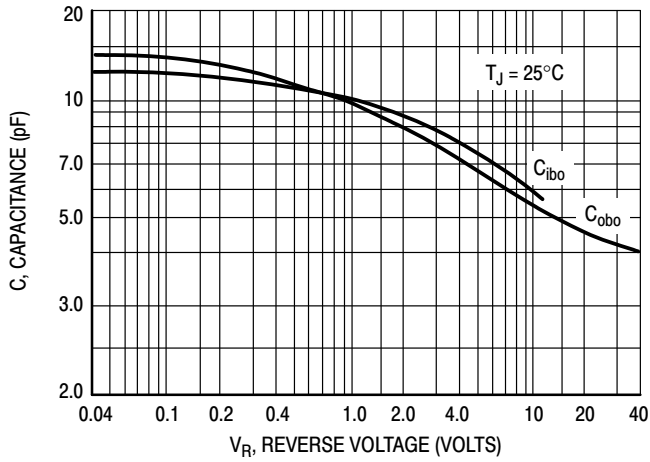

Figure 6. Capacitance

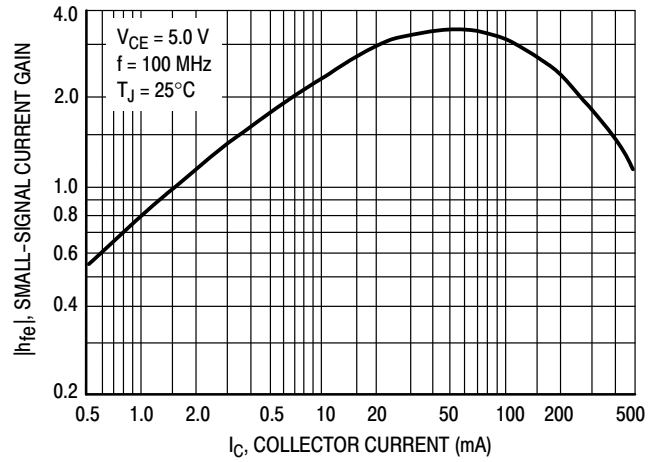

Figure 7. High Frequency Current Gain

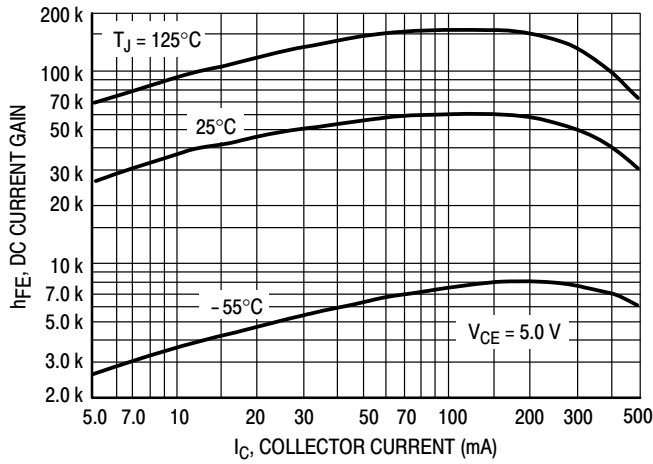

Figure 8. DC Current Gain

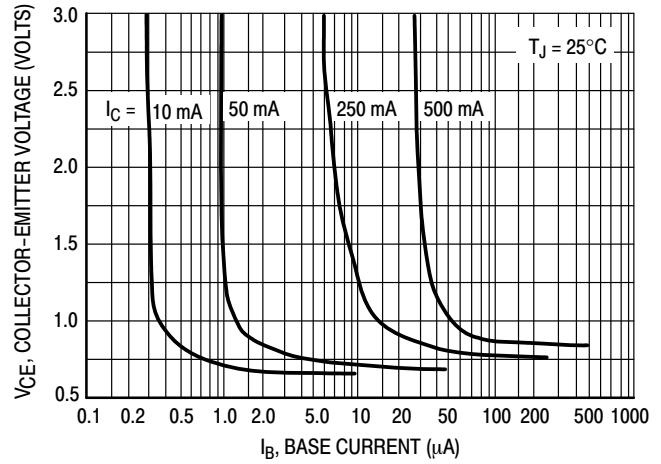

Figure 9. Collector Saturation Region

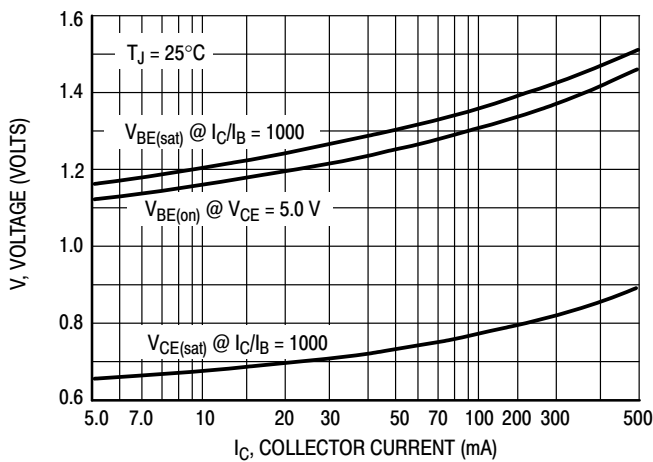

Figure 10. "On" Voltages

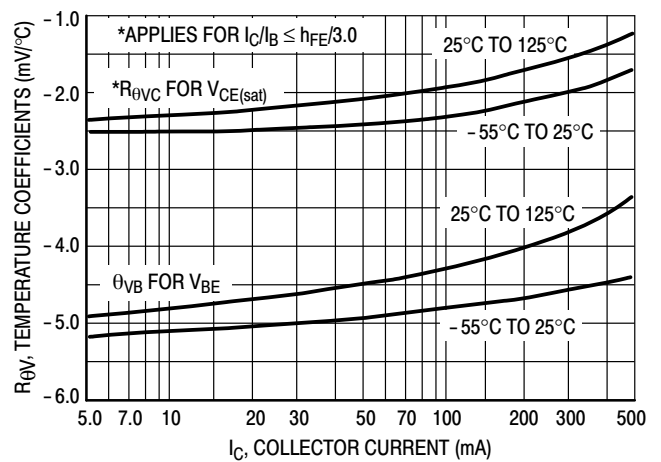

Figure 11. Temperature Coefficients

BC517

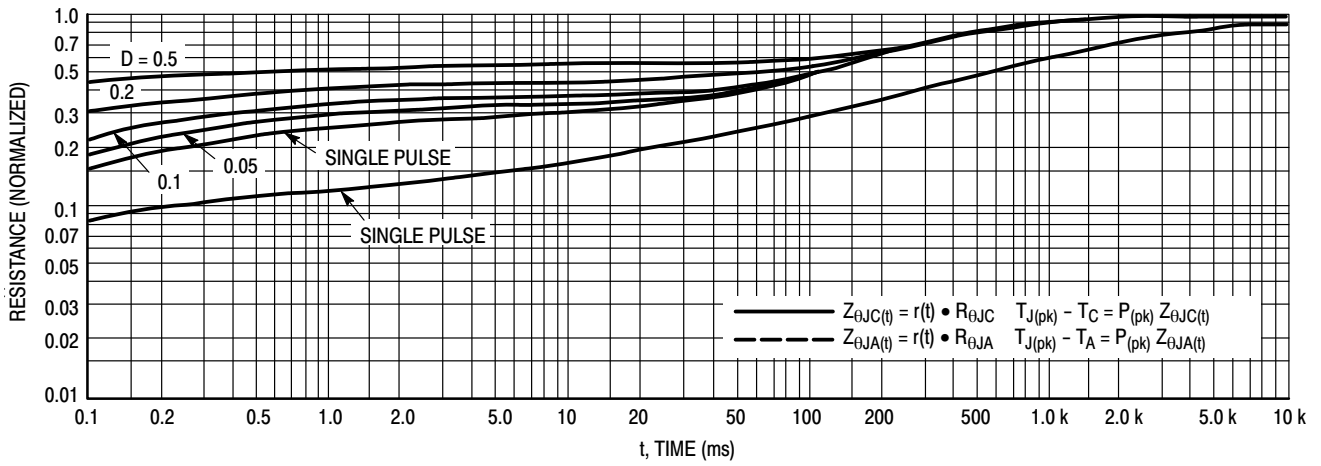

Figure 12. Thermal Response

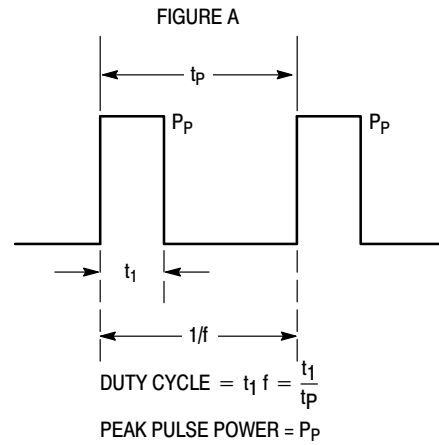
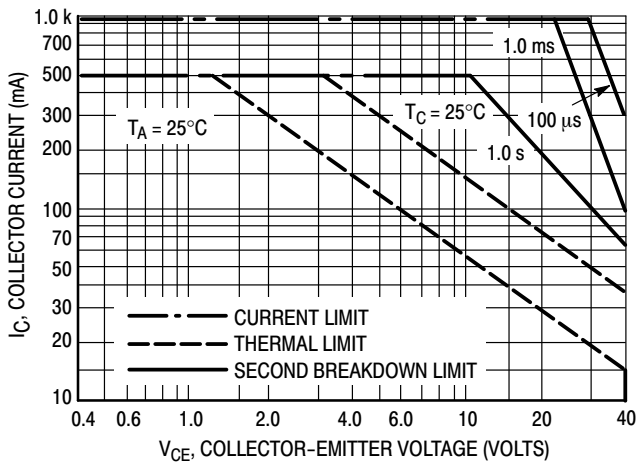

Figure 13. Active Region Safe Operating Area Design Note: Use of Transient Thermal Resistance Data

BC517

PACKAGE DIMENSIONS

TO-92 (TO-226)

CASE 29-11

ISSUE AM

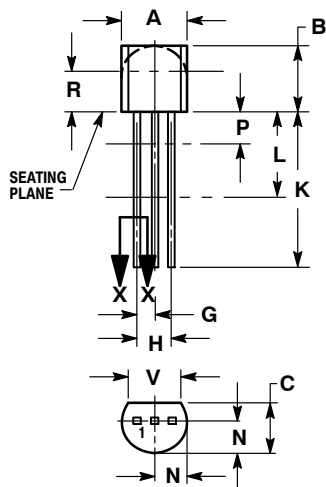

STRAIGHT LEAD
BULK PACK

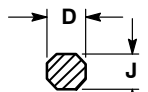

SECTION X-X

NOTES:

1. DIMENSIONING AND TOLERANCING PER ANSI Y14.5M, 1982.
2. CONTROLLING DIMENSION: INCH.
3. CONTOUR OF PACKAGE BEYOND DIMENSION R IS UNCONTROLLED.
4. LEAD DIMENSION IS UNCONTROLLED IN P AND BEYOND DIMENSION K MINIMUM.

| DIM | INCHES | | MILLIMETERS | |
|-----|--------|-------|-------------|-------|
| | MIN | MAX | MIN | MAX |
| A | 0.175 | 0.205 | 4.45 | 5.20 |
| B | 0.170 | 0.210 | 4.32 | 5.33 |
| C | 0.125 | 0.165 | 3.18 | 4.19 |
| D | 0.016 | 0.021 | 0.407 | 0.533 |
| G | 0.045 | 0.055 | 1.15 | 1.39 |
| H | 0.095 | 0.105 | 2.42 | 2.66 |
| J | 0.015 | 0.020 | 0.39 | 0.50 |
| K | 0.500 | --- | 12.70 | --- |
| L | 0.250 | --- | 6.35 | --- |
| N | 0.080 | 0.105 | 2.04 | 2.66 |
| P | --- | 0.100 | --- | 2.54 |
| R | 0.115 | --- | 2.93 | --- |
| V | 0.135 | --- | 3.43 | --- |

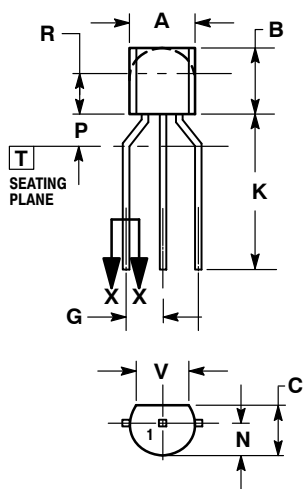

BENT LEAD
TAPE & REEL
AMMO PACK

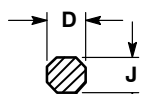

SECTION X-X

NOTES:

1. DIMENSIONING AND TOLERANCING PER ASME Y14.5M, 1994.
2. CONTROLLING DIMENSION: MILLIMETERS.
3. CONTOUR OF PACKAGE BEYOND DIMENSION R IS UNCONTROLLED.
4. LEAD DIMENSION IS UNCONTROLLED IN P AND BEYOND DIMENSION K MINIMUM.

| DIM | MILLIMETERS | |
|-----|-------------|------|
| | MIN | MAX |
| A | 4.45 | 5.20 |
| B | 4.32 | 5.33 |
| C | 3.18 | 4.19 |
| D | 0.40 | 0.54 |
| G | 2.40 | 2.80 |
| J | 0.39 | 0.50 |
| K | 12.70 | --- |
| N | 2.04 | 2.66 |
| P | 1.50 | 4.00 |
| R | 2.93 | --- |
| V | 3.43 | --- |

STYLE 17:

1. COLLECTOR
2. BASE
3. EMITTER

ON Semiconductor and  are registered trademarks of Semiconductor Components Industries, LLC (SCILLC). SCILLC reserves the right to make changes without further notice to any products herein. SCILLC makes no warranty, representation or guarantee regarding the suitability of its products for any particular purpose, nor does SCILLC assume any liability arising out of the application or use of any product or circuit, and specifically disclaims any and all liability, including without limitation special, consequential or incidental damages. "Typical" parameters which may be provided in SCILLC data sheets and/or specifications can and do vary in different applications and actual performance may vary over time. All operating parameters, including "Typicals" must be validated for each customer application by customer's technical experts. SCILLC does not convey any license under its patent rights nor the rights of others. SCILLC products are not designed, intended, or authorized for use as components in systems intended for surgical implant into the body, or other applications intended to support or sustain life, or for any other application in which the failure of the SCILLC product could create a situation where personal injury or death may occur. Should Buyer purchase or use SCILLC products for any such unintended or unauthorized application, Buyer shall indemnify and hold SCILLC and its officers, employees, subsidiaries, affiliates, and distributors harmless against all claims, costs, damages, and expenses, and reasonable attorney fees arising out of, directly or indirectly, any claim of personal injury or death associated with such unintended or unauthorized use, even if such claim alleges that SCILLC was negligent regarding the design or manufacture of the part. SCILLC is an Equal Opportunity/Affirmative Action Employer. This literature is subject to all applicable copyright laws and is not for resale in any manner.

PUBLICATION ORDERING INFORMATION

LITERATURE FULFILLMENT:

Literature Distribution Center for ON Semiconductor
P.O. Box 5163, Denver, Colorado 80217 USA
Phone: 303-675-2175 or 800-344-3860 Toll Free USA/Canada
Fax: 303-675-2176 or 800-344-3867 Toll Free USA/Canada
Email: orderlit@onsemi.com

N. American Technical Support: 800-282-9855 Toll Free
USA/Canada
Europe, Middle East and Africa Technical Support:
Phone: 421 33 790 2910
Japan Customer Focus Center
Phone: 81-3-5773-3850

ON Semiconductor Website: www.onsemi.com

Order Literature: <http://www.onsemi.com/orderlit>

For additional information, please contact your local Sales Representative